

# Status and Prospects on Top Physics at CDF

---



Yuji Takeuchi

University of Tsukuba

for the CDF collaboration

Accelerator and Particle Physics Institute

Feb. 26, 2003

## Outline

- Overview of CDF Run II and Top Physics
- Top Physics Results from Run I
- Status of Top Analysis in CDF Run II
- Top Physics Prospects in CDF Run II
- Summary

# CDF Run II Overview

TEVATRON:  $p\bar{p}$  collider

$\sqrt{s} = 1.8 \text{ TeV (Run I)} \longrightarrow 1.96 \text{ TeV (Run II)}$

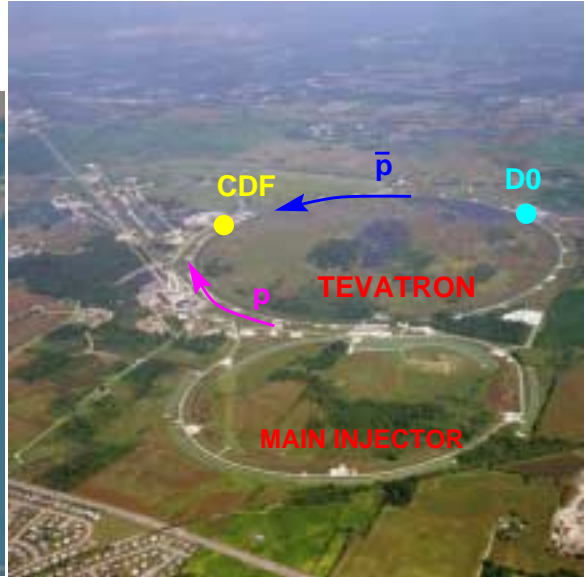

## CDF Run II Detector

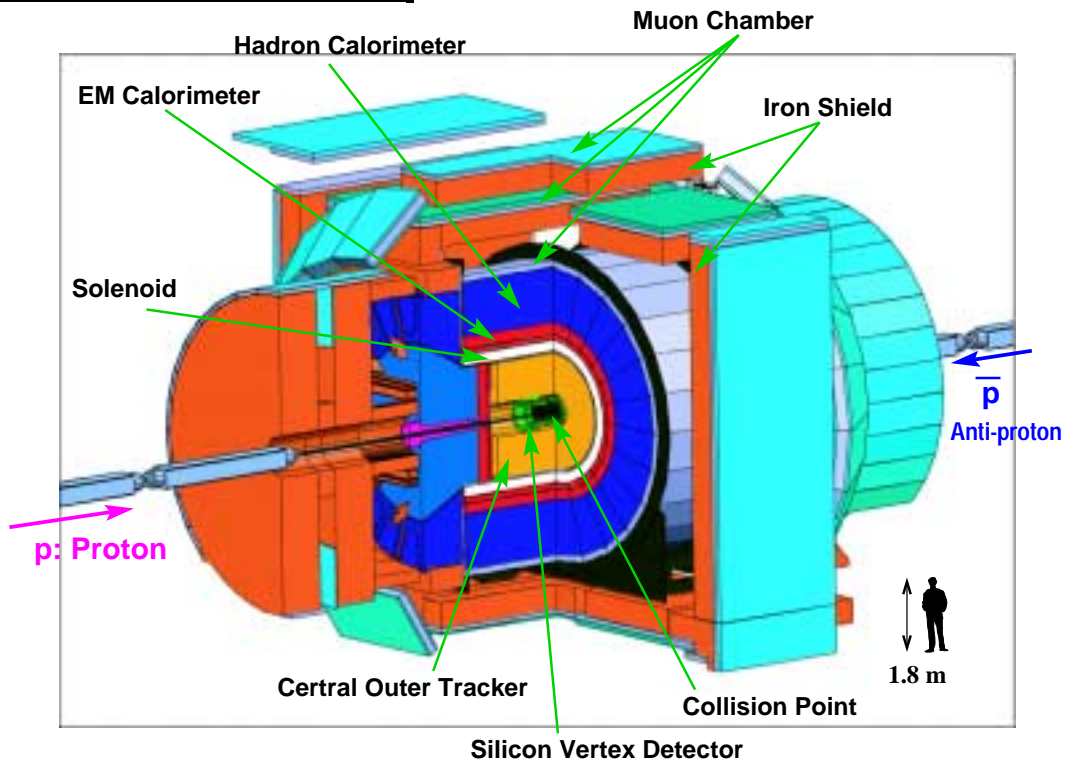

## Integrated Luminosity

- Run 0    4.5 pb<sup>-1</sup>            (1988-1989)
  - Run Ia    19 pb<sup>-1</sup>            (1992-1993)
  - Run Ib    90 pb<sup>-1</sup>            (1994-1996)
- 

Run I total 109 pb<sup>-1</sup>

## Run II

- Run IIa started at March, 2001.
- So far(**mid-Dec, 2002**) obtained  $\sim 80$  pb<sup>-1</sup> as good runs ( $\sim 60$  pb<sup>-1</sup> w/ Silicon).
- **Run IIa** will last until end of 2004.
- The luminosity goal for **Run IIa** is **2 fb<sup>-1</sup>**.
- 6-month shutdown to upgrade to **Run IIb** in 2005.
- The luminosity goal for **Run IIa+Run IIb** is **15 fb<sup>-1</sup>**.

# Brief Introduction of Top Physics

- Top quark in the Standard Model:  
Partner of b-quark in SU(2) doublet of weak isospin in the third generation.

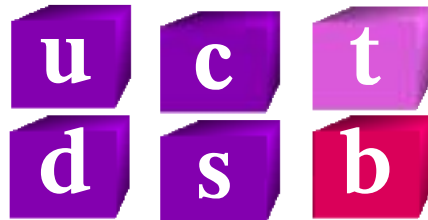

- Mass:  $M_t \approx 175 \text{ GeV}/c^2$   
Width:  $\Gamma_t \simeq 1.42 \text{ GeV}$
  - Top quark decays before hadronization.
  - Yukawa coupling  $\sqrt{2} \frac{m_t}{v} \approx 1$
  - Special role in electroweak symmetry breaking?
- 
- Discovered by CDF and D0 in 1995

CDF : F. Abe *et al.* Phys. Rev. Lett. 74 (1995) 2626

D0 : S. Abachi *et al.* Phys. Rev. Lett. 74 (1995) 2632

# Top Quark Production at Tevatron

## $t\bar{t}$ pair production thru. strong interaction

$$\sigma(tt\bar{t}) \sim 5 \text{ pb at } \sqrt{s} = 1.8 \text{ TeV}$$

$$\sim 7 \text{ pb at } \sqrt{s} = 1.96 \text{ TeV}$$

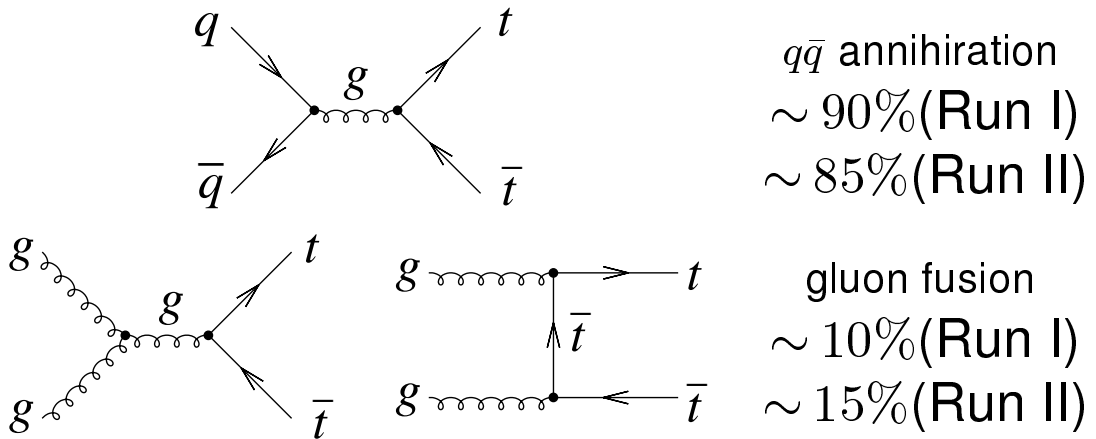

## Single-top production via EW interaction

$$\sigma(\text{single} - t) \sim 2.4 \text{ pb at } \sqrt{s} = 1.8 \text{ TeV}$$

$$\sim 3 \text{ pb at } \sqrt{s} = 1.96 \text{ TeV}$$

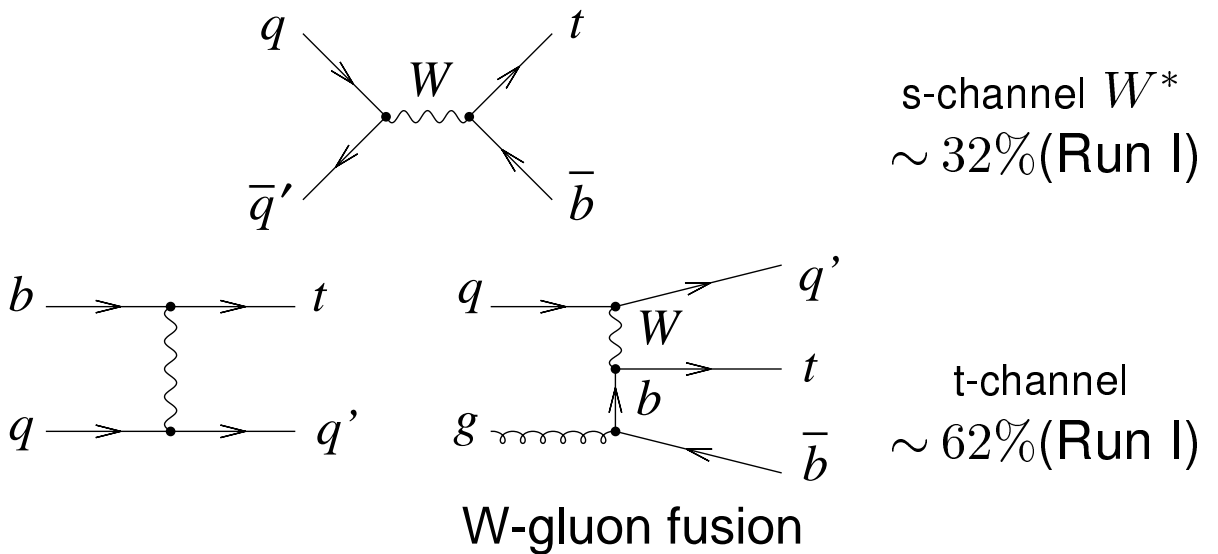

### 3 classes of signal in $t\bar{t}$ production

- In Standard model, top quark goes  $W+b$  at a rate of  $\sim 100\%$ :  

$$\text{Br}(t \rightarrow W^+b) \simeq 1$$
- Decay channels of  $t\bar{t}$  pair

$t \rightarrow W^+b$	<div style="display: flex; justify-content: space-around;"> <div style="background-color: red; width: 20px; height: 20px;"></div> <div style="background-color: green; width: 20px; height: 20px;"></div> <div style="background-color: blue; width: 20px; height: 20px;"></div> </div>
$\hookrightarrow$	
$\bar{t} \rightarrow W^-b$	<div style="display: flex; justify-content: space-around;"> <div style="background-color: red; width: 20px; height: 20px;"></div> <div style="background-color: green; width: 20px; height: 20px;"></div> <div style="background-color: blue; width: 20px; height: 20px;"></div> </div>
$\hookrightarrow$	



### Fraction of decay channels of $t\bar{t}$

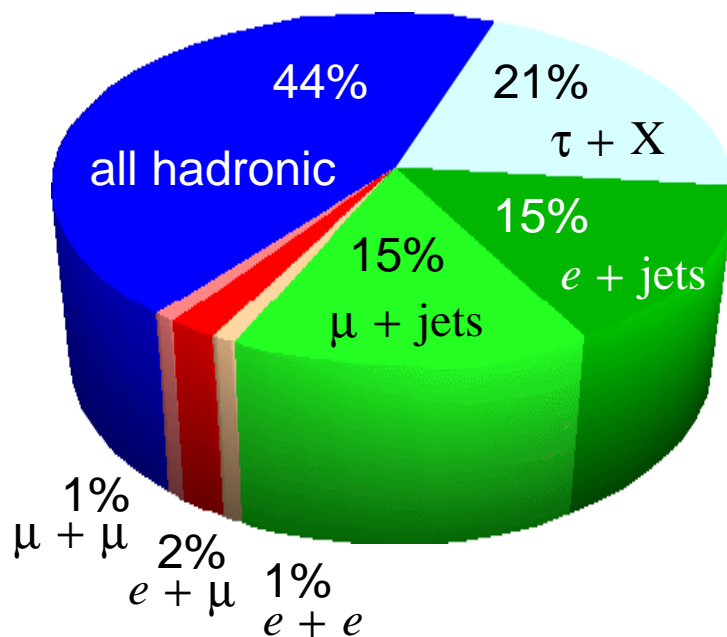

# Results of top physics in CDF Run I

## $t\bar{t}$ production cross section in Run I

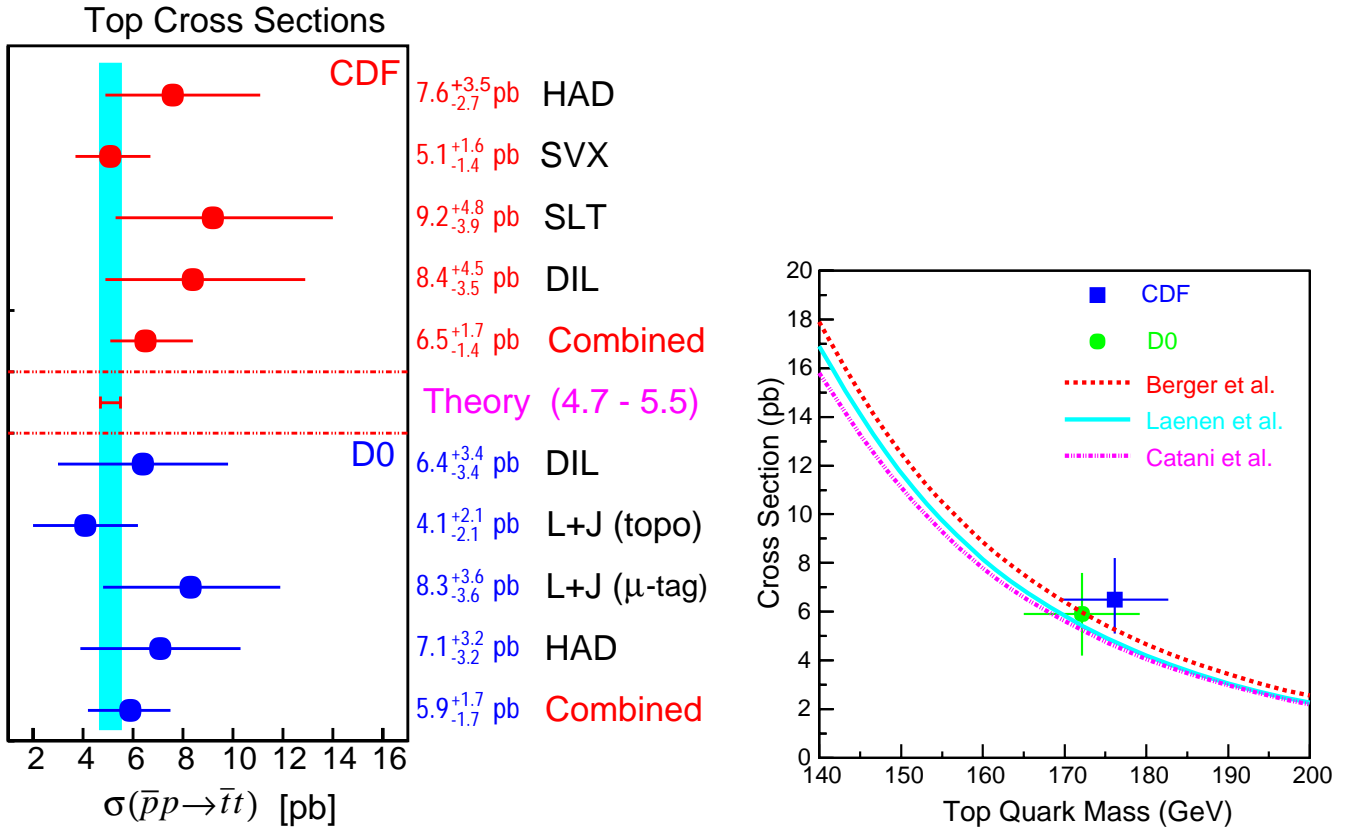

- Several independent measurement of  $\sigma_{t\bar{t}}$ .  
The combined result of CDF run I is:

$$\sigma_{t\bar{t}} = 6.5^{+1.7}_{-1.4} \text{ pb at } \sqrt{s} = 1.8 \text{ TeV}$$

- Test of perturbative QCD predictions.
  - NLO( $O(\alpha_s^3)$ )
  - Soft gluon resummation
- In good agreement with predictions.

# Top quark mass in Run I

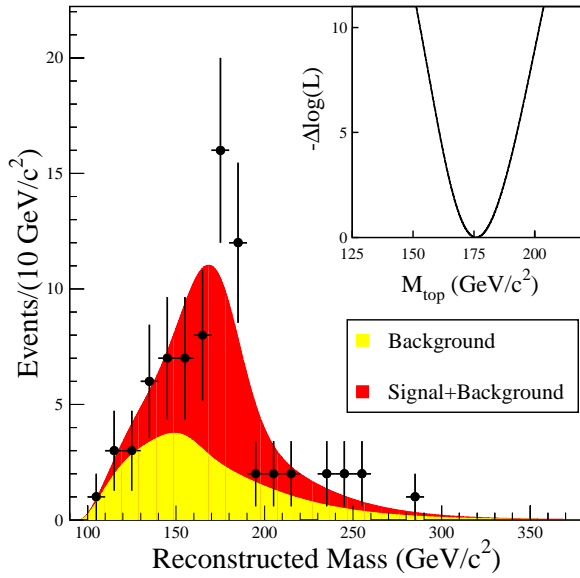

l+jets 76 events

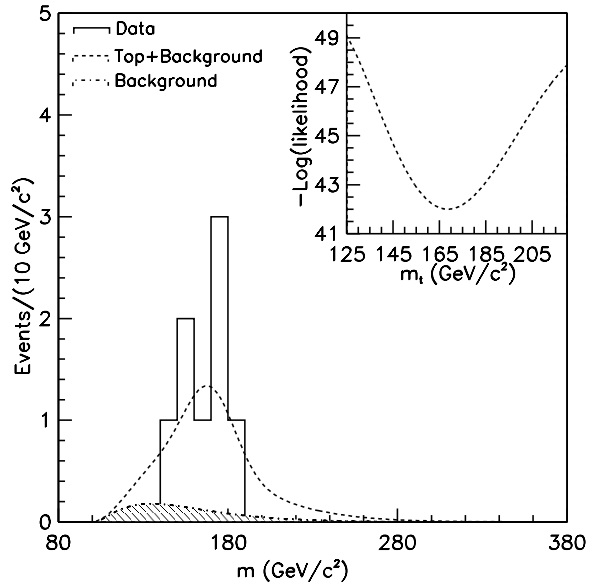

Dilepton 8 events

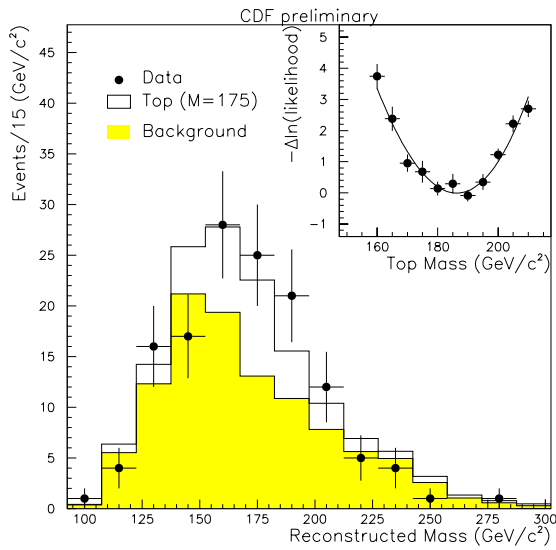

All hadronic 187 events

## Tevatron Top Quark Mass Measurements

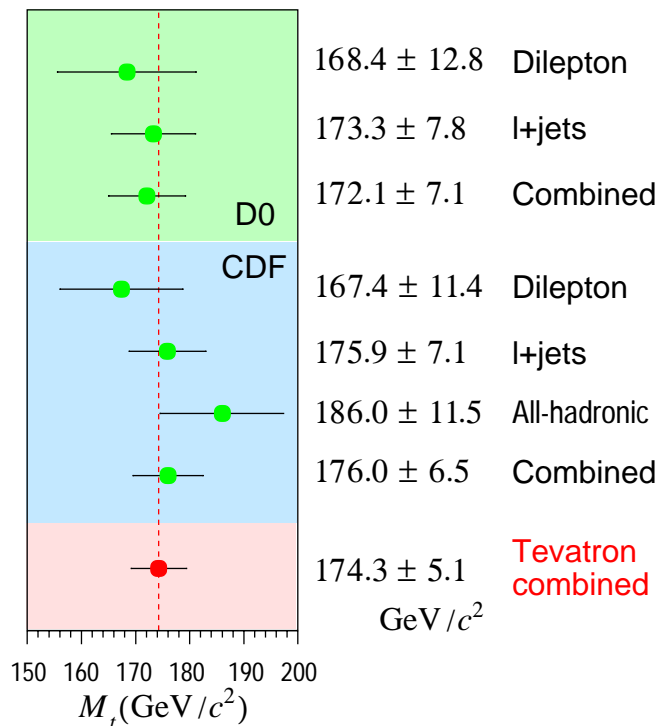

The combined result of CDF in Run I is:

$$M_t = 176.0 \pm 6.5 \text{ GeV}/c^2$$



# Topics on top quark mass

- Important parameter for predictions of SM via radiative corrections.

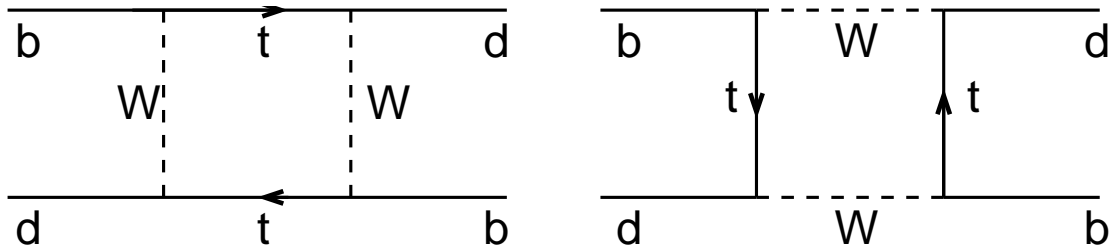

- Measurements of  $M_W$  and  $m_t$  constrain  $M_H$ .  

$$\delta M_W = f(m_t^2, \log M_H)$$

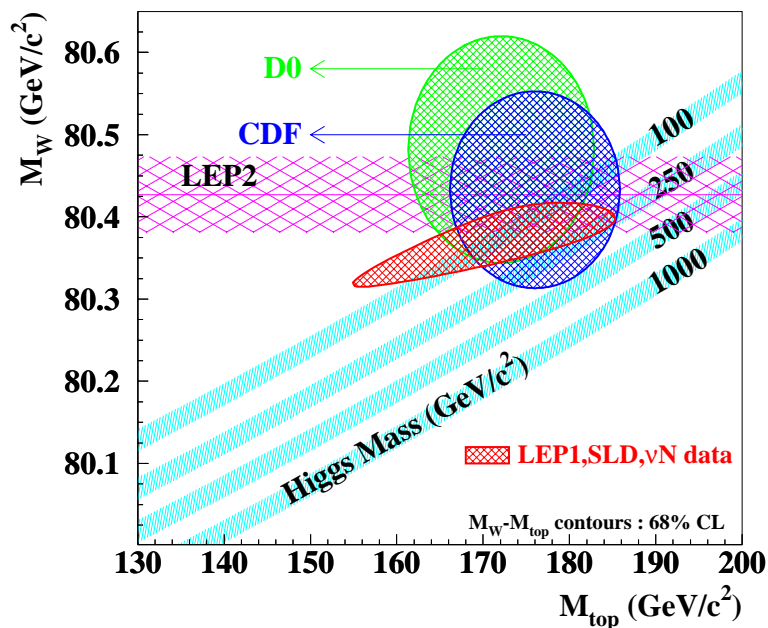
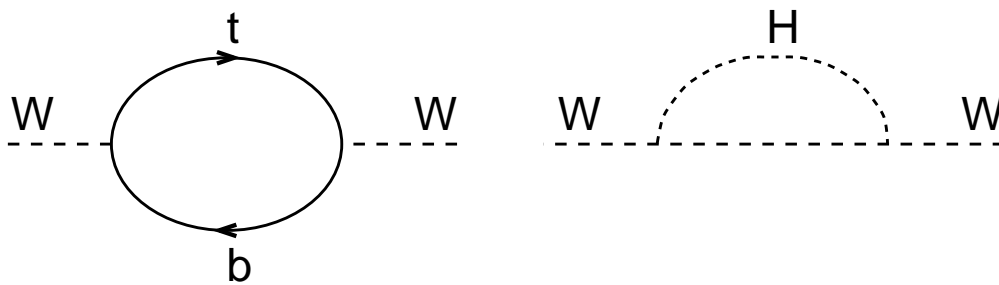

# W helicity in top decays

In Standard Model (V-A theory), top quark decays only to longitudinally polarized or left-handed W.

$$h_W = 0 \text{ or } -1 \quad \frac{\text{Br}(t \rightarrow b W_{\text{long}})}{\text{Br}(t \rightarrow b W_{\text{left}})} = \frac{1}{2} \left( \frac{m_t}{m_W} \right)^2 = \frac{0.70}{0.30}$$

Lepton  $P_T$  distributions in  $t \rightarrow bl\nu$  distinguish the three helicity states of W.

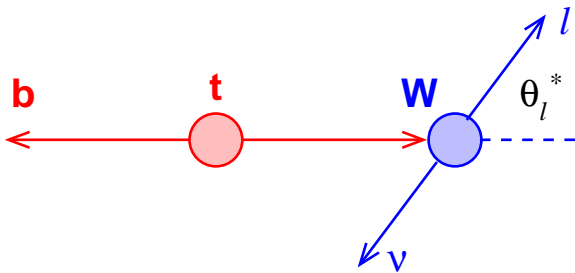

$$|\mathcal{M}(W_{\text{left}})|^2 \propto \frac{1}{4}(1 - \cos\theta_l^*)^2$$

$$|\mathcal{M}(W_{\text{long}})|^2 \propto \frac{1}{2}(\sin\theta_l^*)^2$$

$$|\mathcal{M}(W_{\text{right}})|^2 \propto \frac{1}{4}(1 + \cos\theta_l^*)^2$$

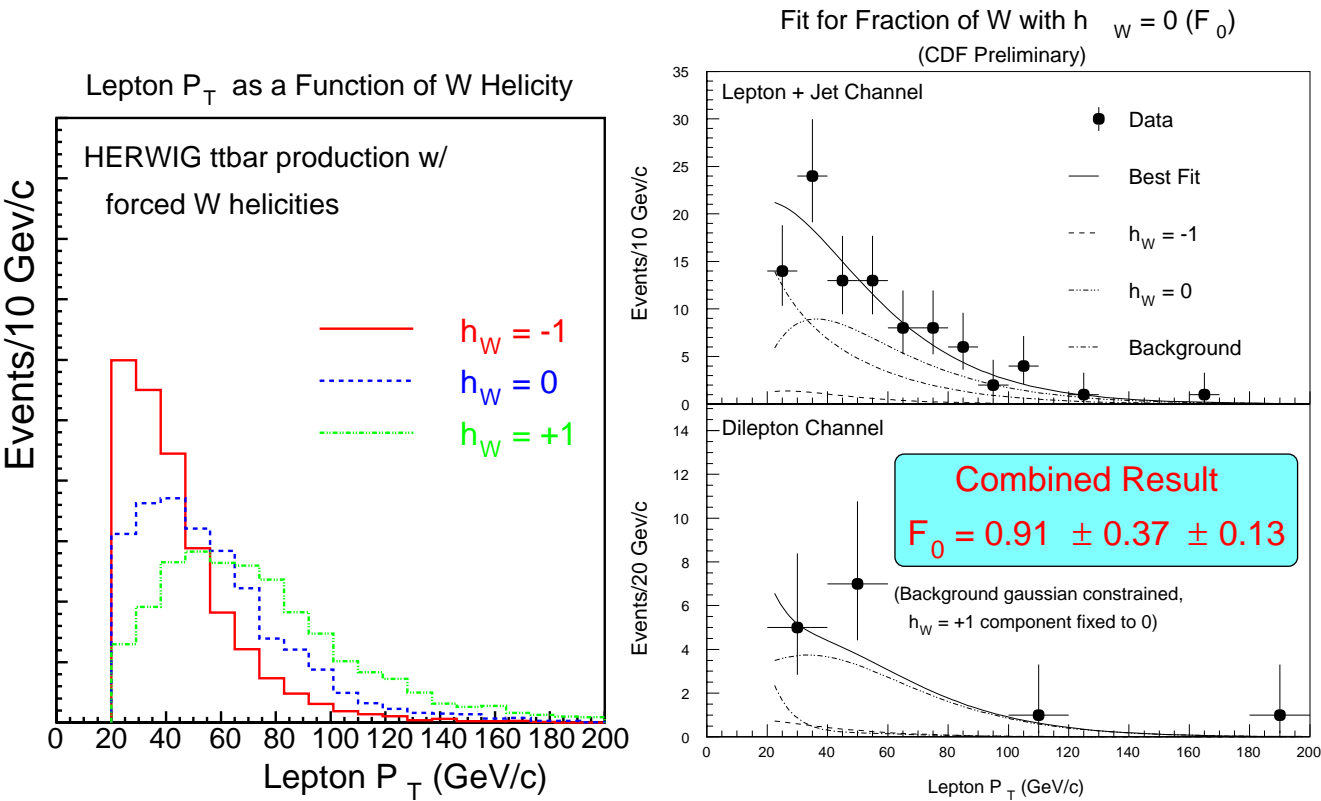

CDF Run I Results	SM
$\mathcal{F}_{\text{long}} = 0.91 \pm 0.37(\text{stat}) \pm 0.12(\text{syst})$	$\iff \sim 0.7$
$\mathcal{F}_{\text{right}} = 0.11 \pm 0.15(\text{stat}) \pm 0.06(\text{syst})$	0

# Single top search in CDF Run I

- Direct measurement of  $|V_{tb}|$  of EW vertex t-W-b.
  - Two dominant production processes at Tevatron.
    - W-gluon fusion:
      - Hard b-jet, W decay, (soft b-jet), light q jet
    - s-channel  $W^*$ :
      - 2 hard b-jets, W decay
- Event signature: W decay + n jets( one or two b-tagged)

→ After all event selections, look at

$$H_t \equiv |\cancel{E}_T| + |E_T(\ell)| + \sum |E_T(\text{all jets})|$$

→ Unbinned maximum likelihood fit to  $H_t$  distribution.

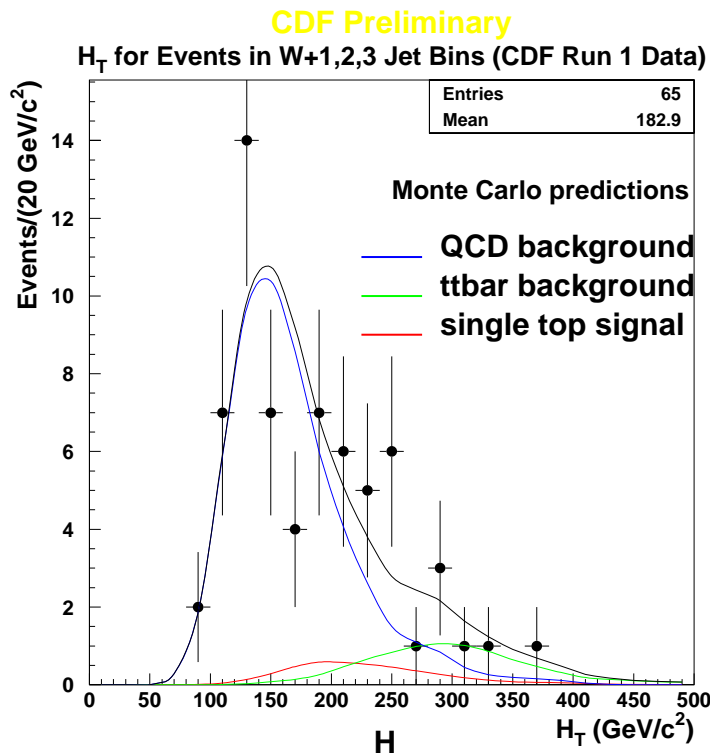

$$\sigma(Wg + W^*) < 14 \text{ pb}$$

## Other results on top physics in CDF Run I

- Branching ratio  $R = \frac{\text{Br}(t \rightarrow Wb)}{\text{Br}(t \rightarrow Wq)}$ .

$$R = 0.94^{+0.31}_{-0.24} \quad |V_{tb}| = 0.97^{+0.16}_{-0.12}$$

(assuming 3 generations)

- Search for FCNC top quark decays.

strongly GIM suppressed in the SM:

$$- \quad p\bar{p} \rightarrow t\bar{t} + X \text{ with } t \rightarrow W + b \text{ and } \bar{t} \rightarrow \bar{u}/\bar{c} + \gamma$$

$$\text{Br}(t \rightarrow u/c + \gamma) < 3.2\% \text{ (95\%CL)}$$

$$- \quad p\bar{p} \rightarrow t\bar{t} + X \text{ with } t \rightarrow W + b \text{ and } \bar{t} \rightarrow \bar{u}/\bar{c} + Z^0$$

$$\text{Br}(t \rightarrow u/c + Z^0) < 33\% \text{ (95\%CL)}$$

## Run II Status

Expect first results on top physics in **March 2003**.

Ongoing analyses on top physics:

- $t\bar{t}$  production cross section in dilepton channel.
- $t\bar{t}$  production cross section in l+4jets channel.
- Top quark mass reconstruction.

### Towards a dilepton $t\bar{t}$ cross section measurement

Calculation is based on the following expression:

$$\sigma_{t\bar{t}}^{\text{dilepton}} = \frac{N_{\text{obs}} - B}{\epsilon_{\text{tot}} \mathcal{L}}$$

Based on the data taken from 2002.3.23 to 2003.1.12

- $\mathcal{L}$  : Total integrated luminosity.  
 $\Rightarrow 109 \text{ pb}^{-1}$  (Run I)  $\longrightarrow$  **Now printing** .
- $N_{\text{obs}}$  : Number of observed candidates.  
 $\Rightarrow 9/109 \text{ pb}^{-1}$  (Run I)  $\longrightarrow$  **Now printing** .
- $B$  : Total background estimate.  
Following background sources are considered.
  - $WW, Z \rightarrow \tau\tau, \text{Drell-Yan, and Fake}(\text{jet} \rightarrow \ell)$ $\Rightarrow 2.4 \pm 0.5/109 \text{ pb}^{-1}$  (Run I)  $\longrightarrow$  **Now printing** .
- $\epsilon_{\text{tot}}$  : Total signal acceptance.  
 $\Rightarrow 0.76\%$  (Run I)  $\longrightarrow$  **Now printing** .

All items are about to be finalized!

# A top dielectron candidate

-  $e^+e^-$ , two jets with a large missing  $E_t$  -

Run=136286, event=54713

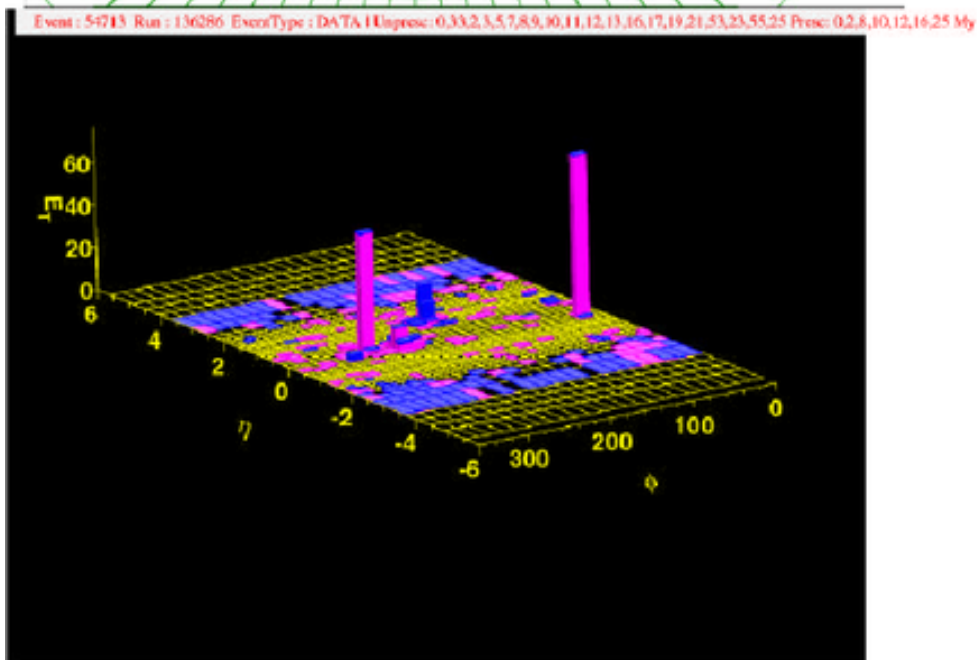
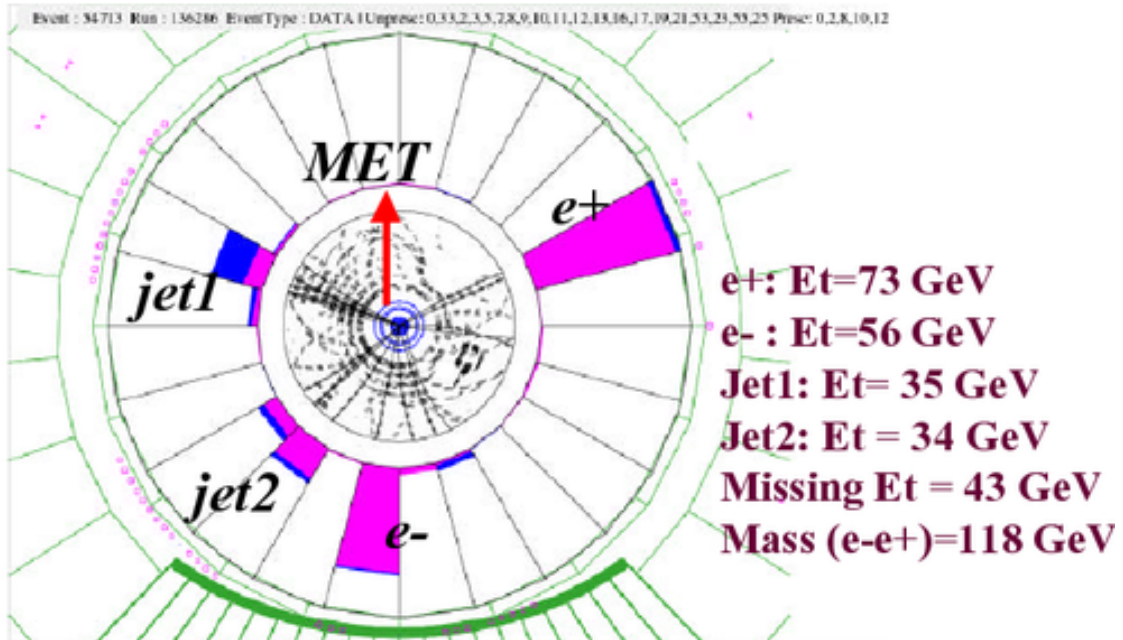

**l+4jets candidate**

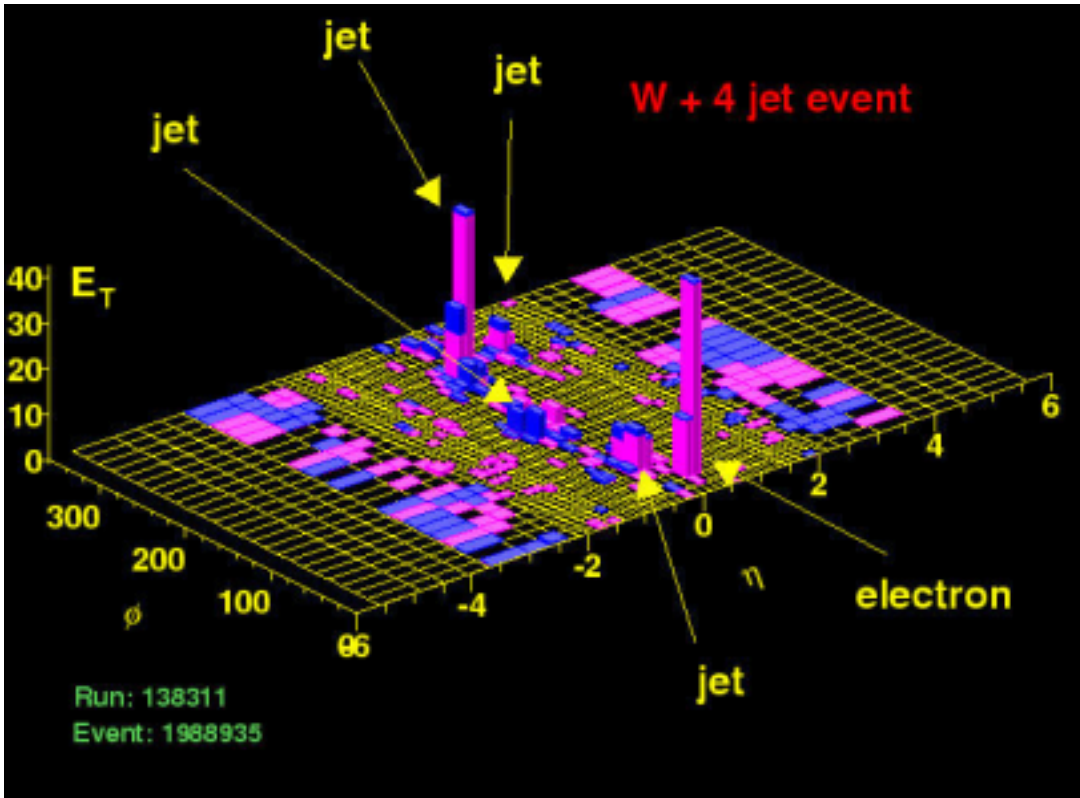

**W candidates in Run II CDF data**

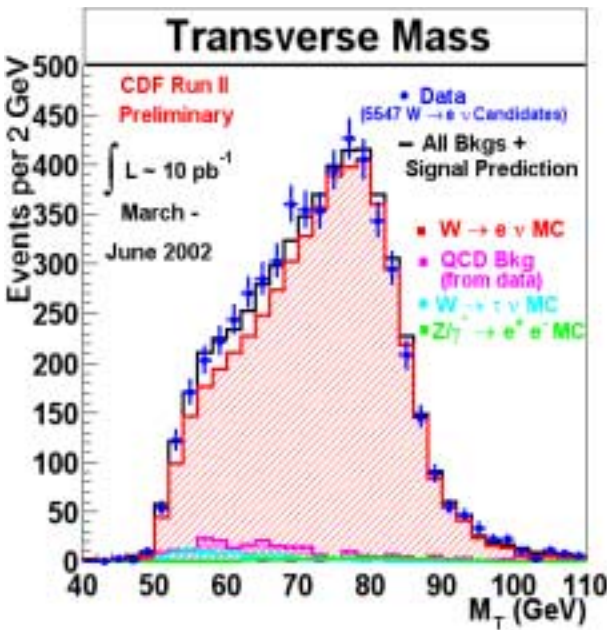

**$W \rightarrow e\nu$  events**

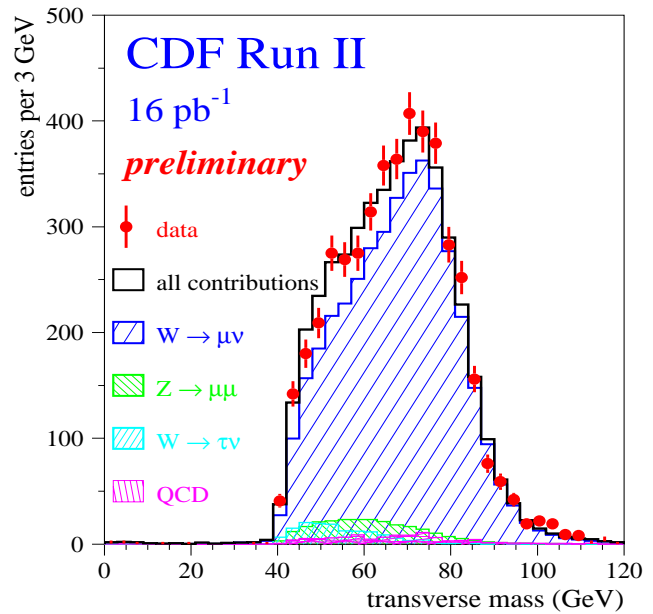

**$W \rightarrow \mu\nu$  events**

# Run II Prospects

Run IIa luminosity goal is  $2 \text{ fb}^{-1}$ . This means at least **20x** higher statistics, which will allow:

## Top quark mass

→  $\delta M_t : 6.5 \text{ GeV}/c^2$  (Run I) →  **$3 \text{ GeV}/c^2$**  (Run II)

→ Constraint for higgs mass:  $\delta M_h / M_h \sim 40\%$

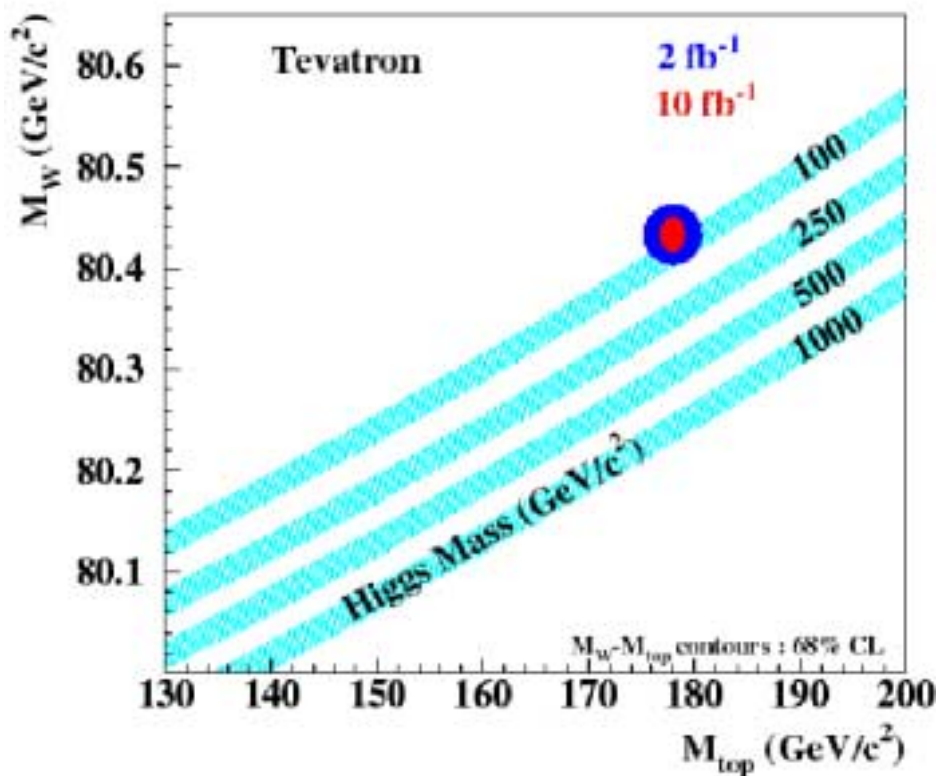

→ Expected accuracies by the end of Run IIb:

$$\delta M_t \approx 1.4 \text{ GeV}/c^2, \quad \delta M_W \approx 16 \text{ MeV}/c^2$$

$$\implies \delta M_h / M_h \sim 25\%$$



## $t\bar{t}$ spin correlations

- Top quark decays before losing the spin information at production.
- $\sim 90\%$  of  $t\bar{t}$  pairs produced at Tevatron come from  $q\bar{q}$  annihilation.

→ Only like-spin combinations in  $t\bar{t}$ , if we take an optimal spin quantization basis.

⇒ "Off-diagonal basis"

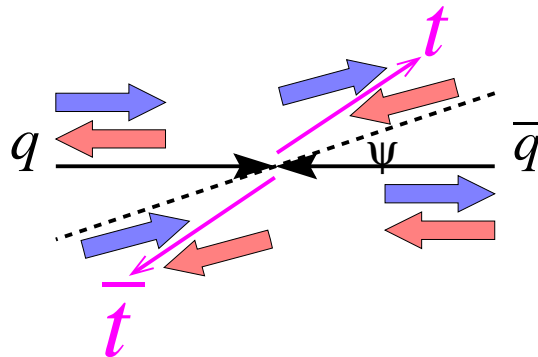

- Top spin can be measured by lepton flight direction in top the rest frame.

## Herwig6.5 generator level

Off-diagonal basis  
Asym =  $0.2036 \pm 0.0032$

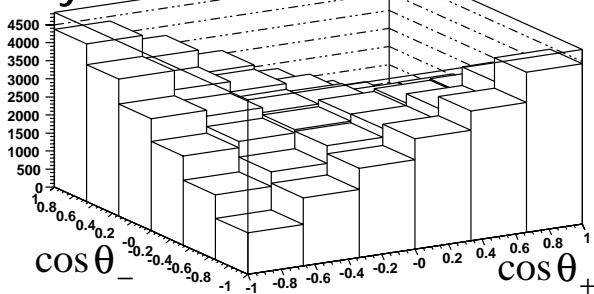

w/ Spin correlation

Off-diagonal basis  
Asym =  $0.0018 \pm 0.0032$

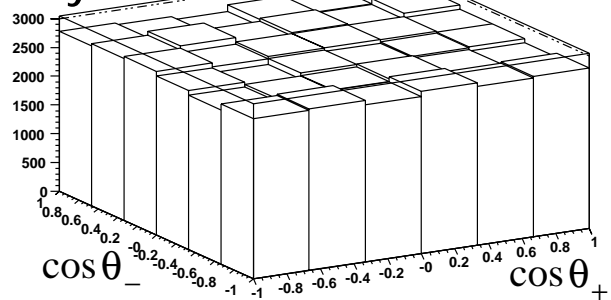

w/o Spin correlation

- Run IIa will provide up a good opportunity for observing the  $t\bar{t}$  spin correlations.

## $t\bar{t}$ production cross-section

$$\delta\sigma_{t\bar{t}} : 25\% \text{ (CDF Run I)} \longrightarrow 10\% (2 \text{ fb}^{-1}) \\ \longrightarrow 5\% (15 \text{ fb}^{-1})$$

## Single top production cross-section

- Observe 100-200 single top events.
- $\Gamma(t \rightarrow Wb) \approx 25\%$
- $\delta|V_{tb}| \approx 12\%$

## W helicity in top decay

- $\delta\mathcal{F}_{\text{long}} : 0.4 \text{ (Run I)} \longrightarrow 0.09 (2 \text{ fb}^{-1}) \\ \longrightarrow 0.04 (15 \text{ fb}^{-1})$
- $\delta\mathcal{F}_{\text{right}} : 0.15 \text{ (Run I)} \longrightarrow 0.03 (2 \text{ fb}^{-1}) \\ \longrightarrow 0.01 (15 \text{ fb}^{-1})$

## Search for FCNC top decay

- $\text{Br}(t \rightarrow u/c + \gamma) < 2.8 \times 10^{-3}$
- $\text{Br}(t \rightarrow u/c + Z^0) < 1.3 \times 10^{-2}$

## Summary

- Top quark is a very interesting particle
  - Large mass and decay width.
- Successful top quark physics program at Run I.
  - Consistent with SM.
  - But limited in statistics.
- Entering exciting era of Run II.
  - Precise measurements on top physics are about to begin.
  - We have now the amount of data comparable to Run I.
  - First results of  $t\bar{t}$  cross section and top quark mass in Run II will come **very soon** (hopefully in this March).
- Run II is promised to be prolific of top quarks, and will give us much information about top quark before LHC and Linear collider era.

Luminosity with Tevatron store number

Mon Feb 24 08:15:35 2003

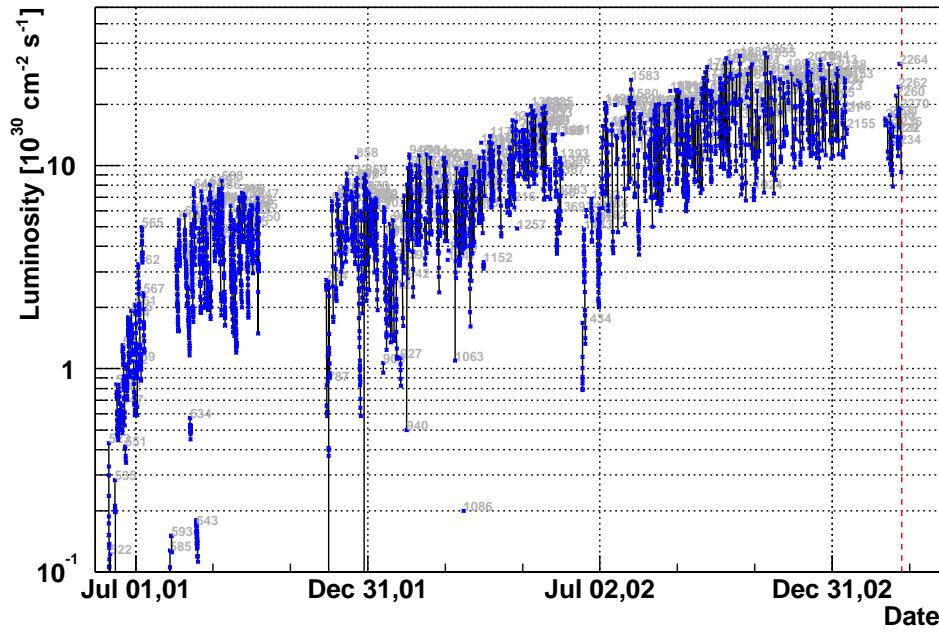

Instantaneous luminosity at each physics runs [ $10^{30} \text{ cm}^{-2} \text{ s}^{-1}$ ]

Number of Integrated and Biased Ladders

Mon Feb 24 08:16:47 2003

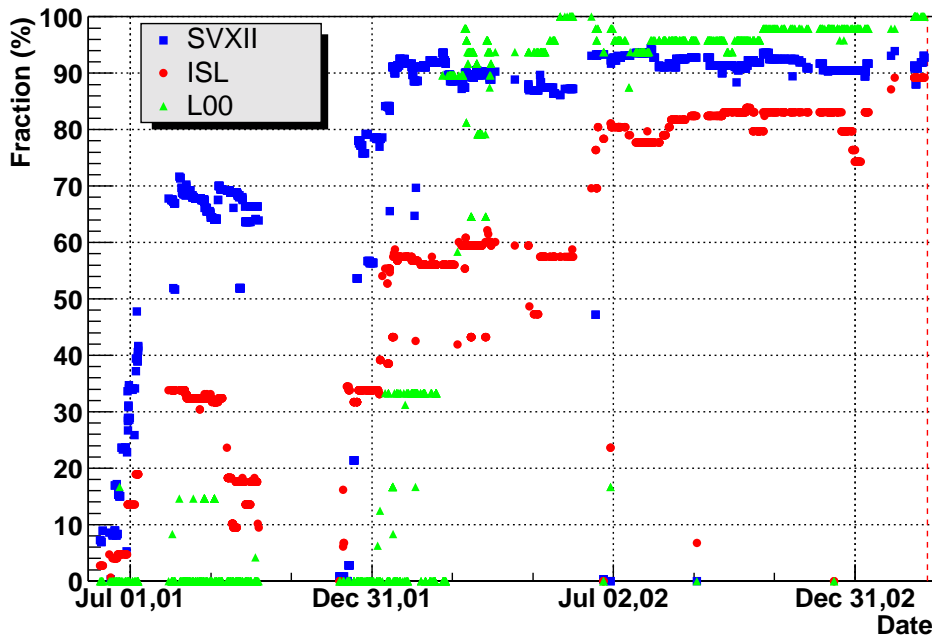

Fraction of readout silicon ladder as a function of time

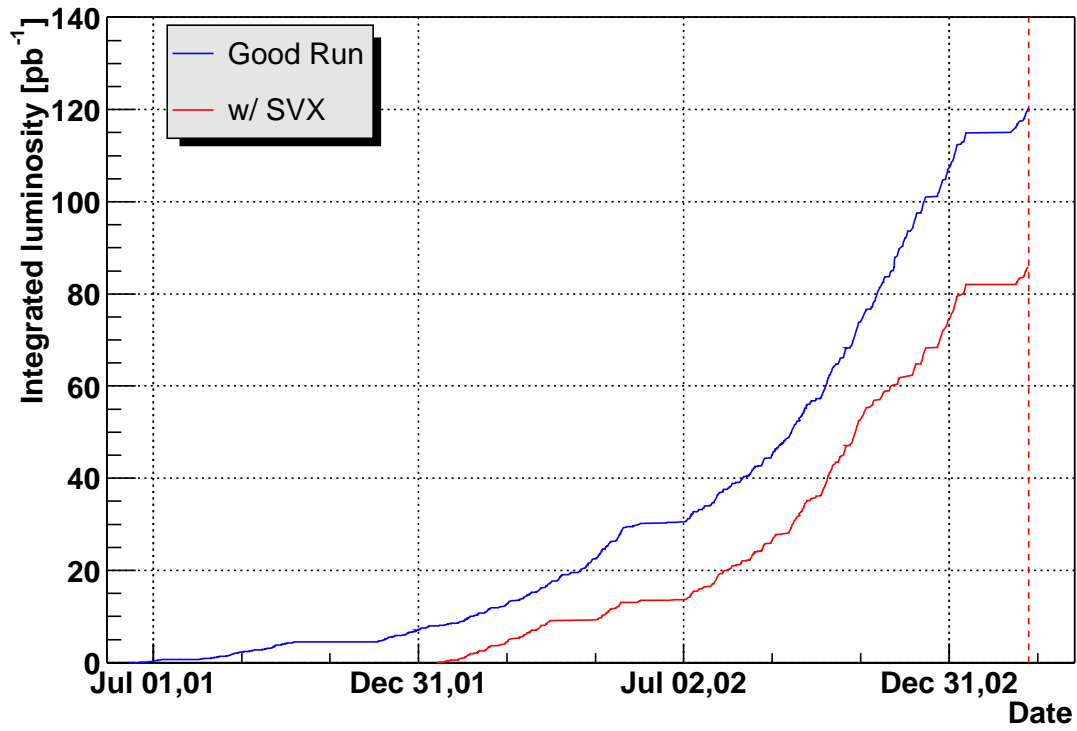

“Online” integrated luminosity to tape [pb<sup>-1</sup>]